

# MODULAR PSA NITROGEN GENERATORS

## NIMOS S5

Performance at inlet pressure: **7,5 bar (g)**

	LP					HP				
<b>Nitrogen purity rate</b>	95 %	97 %	98 %	99 %	99,5 %	99,9 %	99,95 %	99,99 %	99,995 %	99,999 %
<b>Residual oxygen</b>	5 %	3 %	2 %	1 %	0,5 %	0,1 %	500 PPM	100 PPM	50 PPM	10 PPM
<b>Flow nm<sup>3</sup>/h <sup>(1)</sup></b>	<b>72,2</b>	<b>57,8</b>	<b>49,6</b>	<b>39,5</b>	<b>32,4</b>	<b>21,2</b>	<b>17,8</b>	<b>11,9</b>	<b>10,1</b>	<b>6,7</b>
	-	-	-	-	-	-	-	-	-	-

(1) Flow rates at standard atmospheric conditions (20°C/1000 mbar/0% RH)

Performance at inlet pressure: **9,5 bar (g)**

	LP					HP				
<b>Nitrogen purity rate</b>	95 %	97 %	98 %	99 %	99,5 %	99,9 %	99,95 %	99,99 %	99,995 %	99,999 %
<b>Residual oxygen</b>	5 %	3 %	2 %	1 %	0,5 %	0,1 %	500 PPM	100 PPM	50 PPM	10 PPM
<b>Flow nm<sup>3</sup>/h <sup>(1)</sup></b>	<b>86,6</b>	<b>69,3</b>	<b>59,5</b>	<b>47,4</b>	<b>38,8</b>	<b>25,4</b>	<b>21,4</b>	<b>14,3</b>	<b>12,1</b>	<b>8,1</b>
	-	-	-	-	-	-	-	-	-	-

(1) Flow rates at standard atmospheric conditions (20°C/1000 mbar/0% RH)

<sup>(2)</sup> Dew point at atmospheric pressure.

<sup>(3)</sup> Necessary for guarantee performance of the nitrogen generator (integrated).

### Feed Air Requirements

Quality:	Class 1-4-1 ISO 8573.1 Solid < 0,1 µm Dew point < +3°C Oil < 0,01 mg/m <sup>3</sup>
Pressure:	6 - 10 bar (g)
Temperature:	0..... +45°C

### Nitrogen Specifications

Outlet pressure:	0-9 bar(g)
Dew point: <sup>(2)</sup>	< 40°C
Nitrogen process tank: <sup>(3)</sup>	500 lt

### Power Requirements

Power Supply:	230 V / 50 - 60 Hz
Power Consumption:	max. 0,5 kW



**Dimensions & Weight**

M:	440 mm
L:	900 mm
P:	1550 mm
H:	2070 mm
Weight:	530 kg

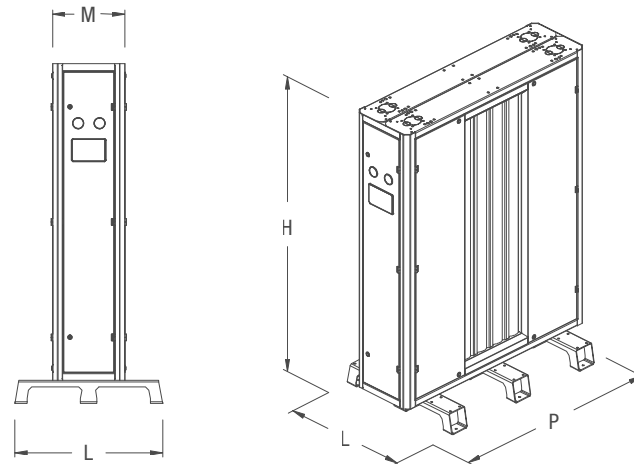

**Connections**

Air inlet:	G1"
N <sub>2</sub> outlet:	G1"
N <sub>2</sub> to process tank:	G1"
N <sub>2</sub> from process tank:	G1"
O <sub>2</sub> enriched air outlet:	G3"

**STANDARD EQUIPMENT AND OPTIONS**

- = standard equipment
- = option

**Control panel**

4 line display	●
----------------	---

**Purity monitoring and control**

O <sub>2</sub> Electrochemical Sensor 0-25 %	○
O <sub>2</sub> Zirconium Sensor 0-25 %	○
O <sub>2</sub> Zirconium Sensor 10-1000 ppm	○
Dew point sensor with indication on display	○
Flow meter with indication on display	○

**Valves and accessories**

Back pressure control valve kit	○
Compressed air pressure sensor	●
Nitrogen buffer pressure sensor	●
Process tank pressure sensor	●
Exhaust silencer	●
Super exhaust silencer extern mounted	○

**Logging and data handling**

Analog output 4-20mA (O <sub>2</sub> level)	●
Modbus RTU	●
Modbus RS485/USB serial converter	○
Profibus connection convert	○
Canbus connection convert	○
Ewon (webserver + sms alarm + data logging)	○
Digital remote control	●
Extern alarm digital input	●

**Necessary accessory**

Process tank with all accessories	500 lt
-----------------------------------	--------

