

MODULAR PSA NITROGEN GENERATORS

NIMOS S6

Performance at inlet pressure: **7,5 bar (g)**

	LP					HP				
Nitrogen purity rate	95 %	97 %	98 %	99 %	99,5 %	99,9 %	99,95 %	99,99 %	99,995 %	99,999 %
Residual oxygen	5 %	3 %	2 %	1 %	0,5 %	0,1 %	500 PPM	100 PPM	50 PPM	10 PPM
Flow nm³/h ⁽¹⁾	86,9	69,5	59,6	47,5	38,9	25,5	21,4	14,4	12,1	8,1
	-	-	-	-	-	-	-	-	-	-

(1) Flow rates at standard atmospheric conditions (20°C/1000 mbar/0% RH)

Performance at inlet pressure: **9,5 bar (g)**

	LP					HP				
Nitrogen purity rate	95 %	97 %	98 %	99 %	99,5 %	99,9 %	99,95 %	99,99 %	99,995 %	99,999 %
Residual oxygen	5 %	3 %	2 %	1 %	0,5 %	0,1 %	500 PPM	100 PPM	50 PPM	10 PPM
Flow nm³/h ⁽¹⁾	104,2	83,3	71,5	57,0	46,7	30,6	25,7	17,2	14,5	9,7
	-	-	-	-	-	-	-	-	-	-

(1) Flow rates at standard atmospheric conditions (20°C/1000 mbar/0% RH)

⁽²⁾ Dew point at atmospheric pressure.

⁽³⁾ Necessary for guarantee performance of the nitrogen generator (integrated).

Feed Air Requirements

Quality:	Class 1-4-1 ISO 8573.1 Solid < 0,1 µm Dew point < +3°C Oil < 0,01 mg/m ³
Pressure:	6 - 10 bar (g)
Temperature:	0..... +45°C

Nitrogen Specifications

Outlet pressure:	0-9 bar(g)
Dew point: ⁽²⁾	< 40°C
Nitrogen process tank: ⁽³⁾	500 lt

Power Requirements

Power Supply:	230 V / 50 - 60 Hz
Power Consumption:	max. 0,5 kW



Dimensions & Weight

M:	440 mm
L:	900 mm
P:	1550 mm
H:	2070 mm
Weight:	600 kg

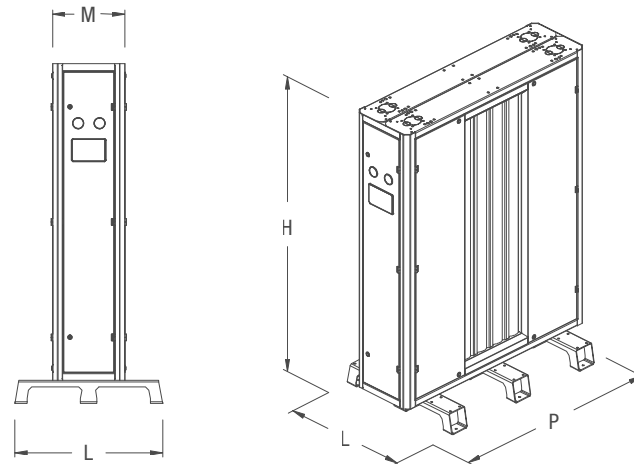

Connections

Air inlet:	G1"
N ₂ outlet:	G1"
N ₂ to process tank:	G1"
N ₂ from process tank:	G1"
O ₂ enriched air outlet:	G3"

STANDARD EQUIPMENT AND OPTIONS

- = standard equipment
- = option

Control panel

4 line display	●
----------------	---

Purity monitoring and control

O ₂ Electrochemical Sensor 0-25 %	○
O ₂ Zirconium Sensor 0-25 %	○
O ₂ Zirconium Sensor 10-1000 ppm	○
Dew point sensor with indication on display	○
Flow meter with indication on display	○

Valves and accessories

Back pressure control valve kit	○
Compressed air pressure sensor	●
Nitrogen buffer pressure sensor	●
Process tank pressure sensor	●
Exhaust silencer	●
Super exhaust silencer extern mounted	○

Logging and data handling

Analog output 4-20mA (O ₂ level)	●
Modbus RTU	●
Modbus RS485/USB serial converter	○
Profibus connection convert	○
Canbus connection convert	○
Ewon (webserver + sms alarm + data logging)	○
Digital remote control	●
Extern alarm digital input	●

Necessary accessory

Process tank with all accessories	500 lt
-----------------------------------	--------

